

11966

[mm]

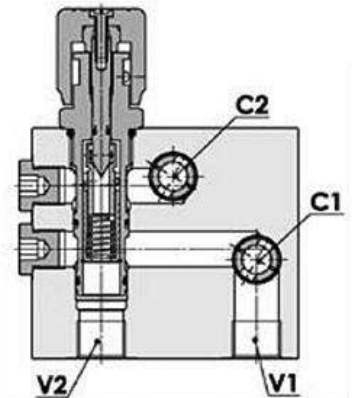
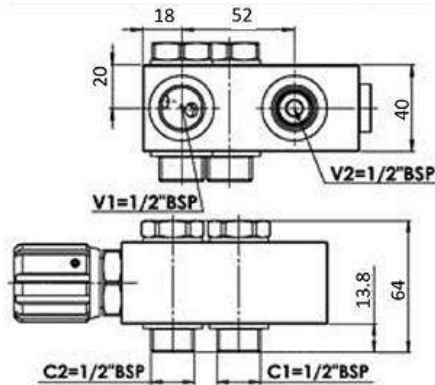
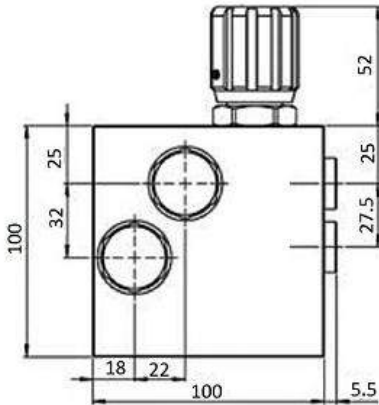
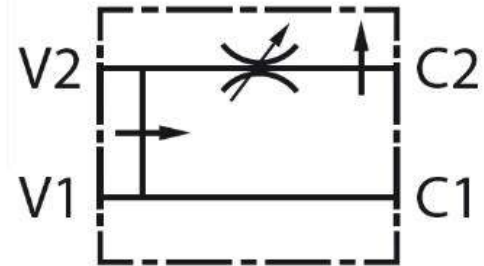

Šifra / Code		11966
Max. Tlak / Max. Pressure	[bar]	250
Max. Pretok / Max. Flow	l/min	90
Priključek / Thread	"	1/2